



intelligent
weighing
solutions



SSC 9200

Bilancia d'egalizzazione

Ottimizzare l'impianto e massimizzare la produttività

Massimizzazione dei profitti

ROI entro 3-12 mesi

Controllo dinamico del limite di peso



SSC 9200

 bilancia d'egalizzazione

La bilancia d'egalizzazione SSC 9200 ottimizza la portata della merce da imballare grazie al controllo dinamico del peso.

I pesi dei prodotti confezionati vengono registrati e analizzati nel software TopControl.

L'intuitivo display con la barra LED integrata facilita il confezionamento rapido e preciso dei prodotti. In questo modo si evita il sovrappeso.

La bilancia d'egalizzazione SSC9200 minimizza il giveaway di ogni singola confezione. Tutti i pesi rilevati vengono registrati nel software centrale TopControl e così la riduzione del peso regalato porta a un aumento dei profitti. La precisione elevata della bilancia e l'intuitività nell'uso consentono notevoli risparmi.

La produttività è notevolmente aumentata. Il processo produttivo è tracciabile e analizzabile.

TopControl
statisticsWeights

TopControl
fruitManager



Display di controllo

Viene utilizzato per elaborare il lavoro inserito.



Registrazione dell'utente

Il lavoratore si collega al terminale tramite un chip RFID.



LED

Indica il raggiungimento del peso appropriato.



Piattaforma di pesatura: calcola il peso ottimale per mantenere l'esborso il più basso possibile.

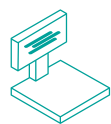

HIGHLIGHTS



Registrazione di lotti d'ingresso e scarti



Massimizzazione del profitto



ROI entro 3-12 mesi



Massima produttività tramite LED-display integrato



Ottimizzazione del giveaway



Dynamische Gewichtsgrenzregelung



Confezionare secondo la normativa WELMEC 6.4/e



Display touch intuitivo con barra a LED integrata



Registrazione efficiente dei tempi di lavoro tramite lettore di transponder integrato



Funzionamento a riempimento o sottrazione configurabile per ogni articolo



Gestione e registrazione completa attraverso il software TopControl

CARATTERISTICHE TECNICHE

Piattaforma di pesatura - Dimensioni	250 x 250 mm 300 x 300 mm 350 x 350 mm 400 x 700 mm con trasportatore a rulli
Alimentazione	Unità di alimentazione 24V
Potenza elettrica	10W
Classe di protezione	IP65
Interfaccia	WLAN 2.4GHz
Display LCD a colori a sfioramento	Display da 3,2 pollici
Lingue operative	DE - IT - EN - ES - CS - FR - SK
(!) Scale non verificabili per uso interno	

PORTATA/DIVISIONE

Portata/ divisione	Cella di misura		Stand alone			con trasportatore a rulli
	Alu	Inox	250 x 250 mm	300 x 300 mm	350 x 350 mm	400 x 700 mm
			Precarico 2,5 kg	Precarico 3,5 kg	Precarico 5,5 kg	Precarico 3,2 kg
6kg / 1g	x	x	x	x	x	
15kg / 2g	x	x		x	x	
20kg / 5g	x			x	x	
30kg / 5g		x			x	
15 kg / 5g	x					x
30 kg / 10g	x					x

Versione	Terminale		Montaggio terminal			Supporto a muro
	verticale	orizzontale	centrato alla piattaforma	Lateralmente alla piattaforma	Appoggiato accanto alla piattaforma	
Piattaforma di pesatura 250 x 250 mm	x	x	x	x	x	x
Piattaforma di pesatura 300 x 300 mm	x	x	x	x	x	x
Piattaforma di pesatura 350 x 350 mm	x	x	x	x	x	x

250 x 250 mm
300 x 300 mm
350 x 350 mm

Piattaforma di pesatura Celle di misura Campo di pesatura

A seconda dell'applicazione, le piattaforme di pesatura sono disponibili in alluminio o inox nelle dimensioni 250 x 250 mm, 300 x 300 mm e 350 x 350 mm con diversi campi di pesatura (vedere i dettagli tecnici).

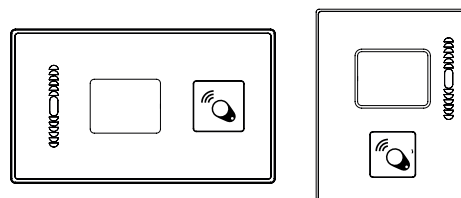

Terminal Display

Il terminale può essere collegato alla rete tramite LAN o WLAN e quindi anche al software TopControl per l'elaborazione e l'analisi degli ordini. Il display convince grazie all'intuitivo display a colori abbinato alla barra LED con cui viene visualizzato il peso.

Esistono 2 versioni del terminale. A seconda dell'applicazione, è necessario il formato verticale o orizzontale.

La registrazione dei lavoratori avviene con un transponder direttamente al terminale.

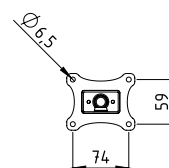

Supporto a muro

Treppiede

Montaggio a parete

Il terminale può essere montato in diversi modi. Sono disponibili supporti nelle varianti piccola, media e alta su cui il terminale può essere montato in formato verticale o orizzontale, centrato o laterale rispetto alla piattaforma.

È anche possibile montare il terminale verticale appoggiato accanto alla piattaforma.

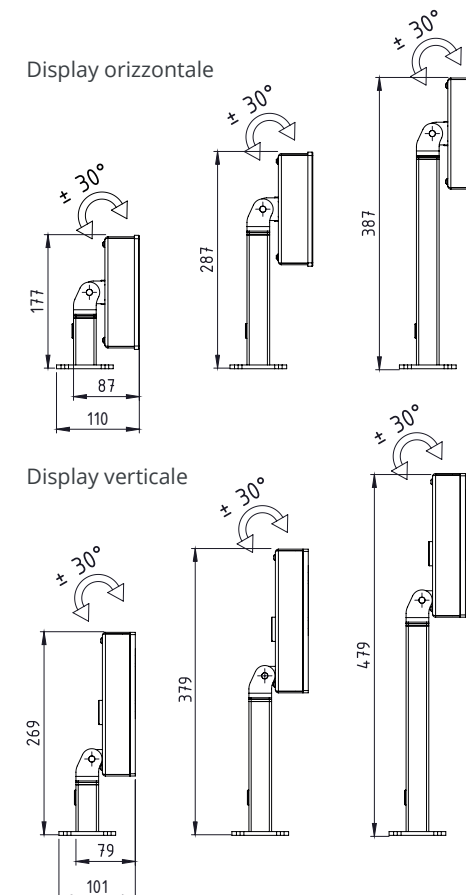

Disegni tecnici

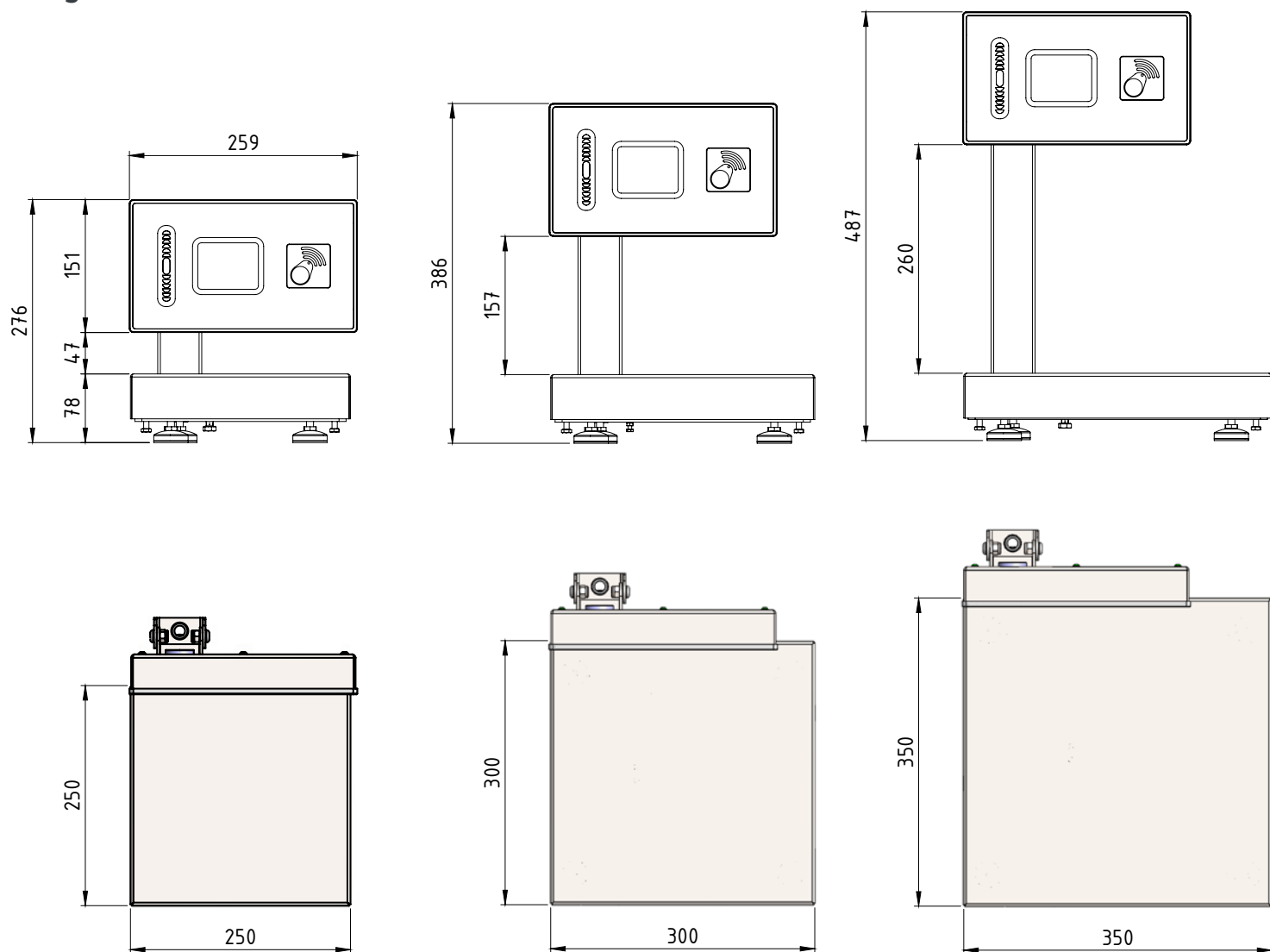

Ottimizzato per verdure e frutta di medie dimensioni, formaggio, carne e pesce.



frutta



verdura



carne



pesce



formaggio

Disegni tecnici

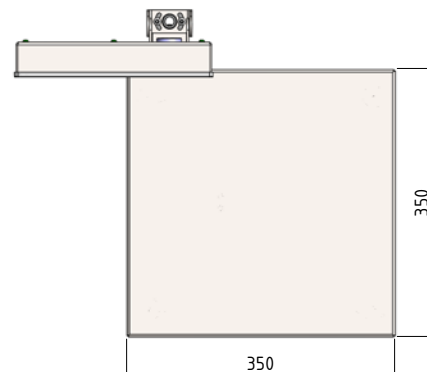
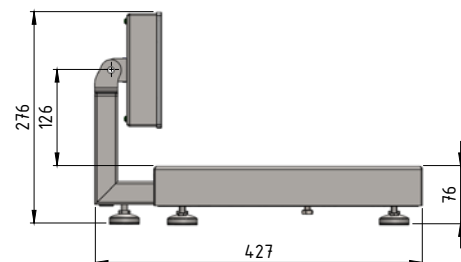
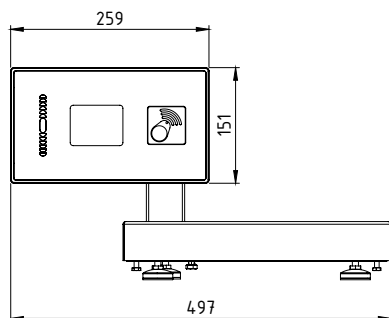
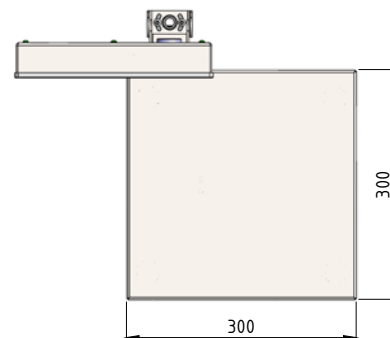
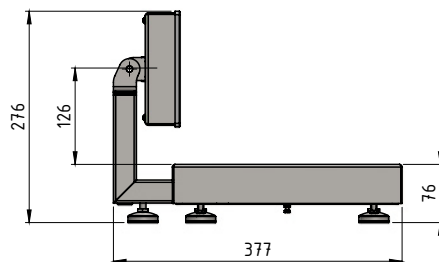
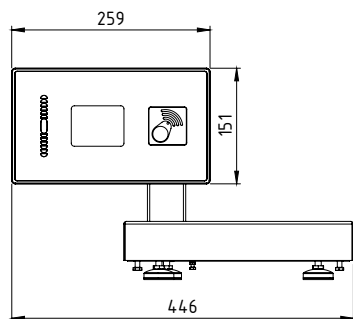

Ottimizzato per verdure e frutta di medie dimensioni, formaggio, carne e pesce.



frutta



verdura



carne



pesce



formaggio

Disegni tecnici

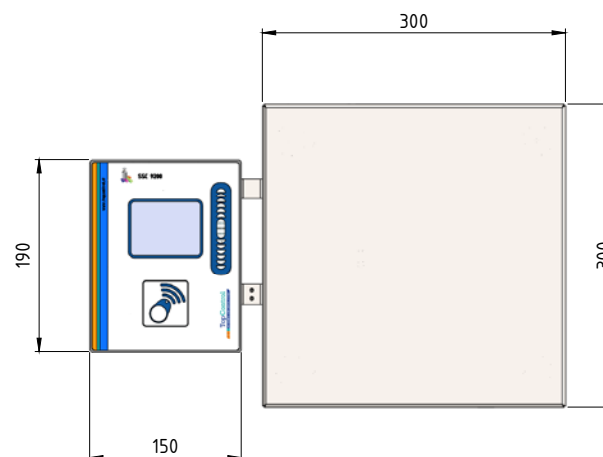
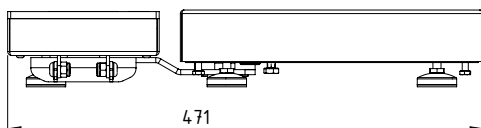
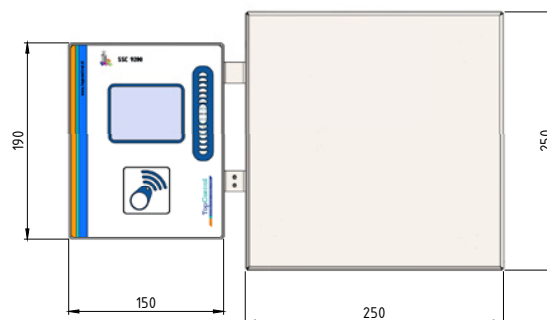
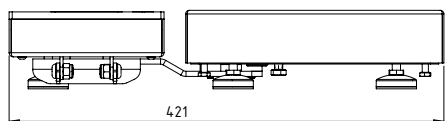

Ottimizzato per verdure e frutta di medie dimensioni, formaggio, carne e pesce.



frutta



verdura



carne



pesce



formaggio

Disegni tecnici

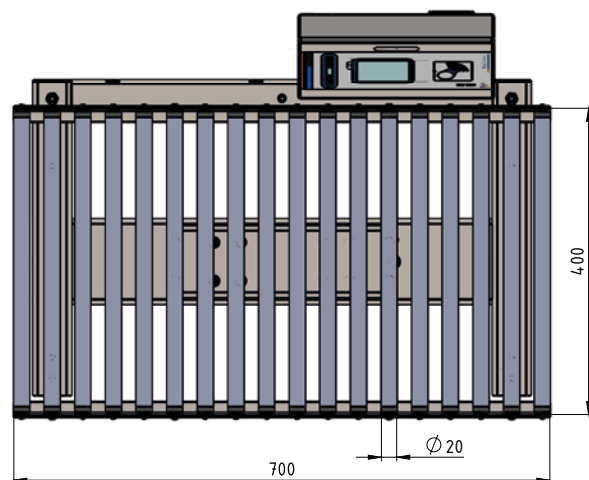
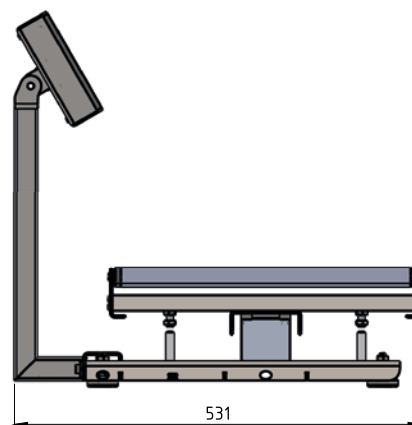
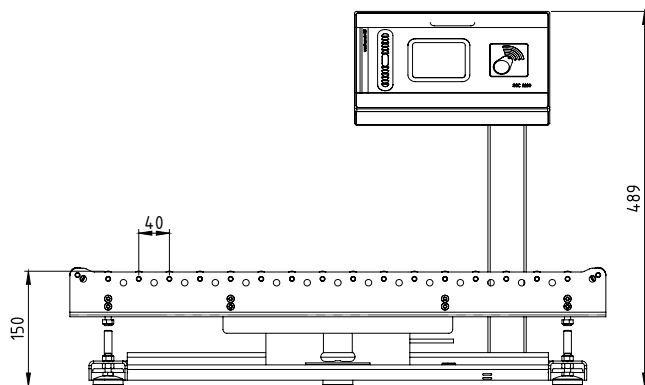

Ottimizzato per verdure e frutta di medie dimensioni, formaggio, carne e pesce.



frutta



verdura



carne



pesce



formaggio

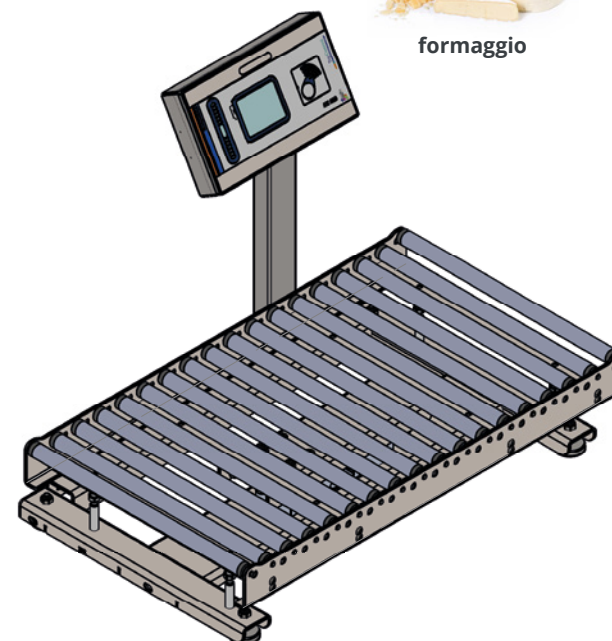

intelligent weighing solutions

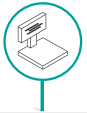

SSC 9200
Bianca d'egalizzazione



RSC 9200
Bilancia ad estrazione



IWS 3000
Tavolo di pesatura



MHP 1000
Combinatore con bilance



MHP 1200
Combinatore con bilance



MHP 1300
Combinatore con bilance



MHP 2000
Combinatore con bilance



MHP 2100
Combinatore con bilance



MHP 3000
Combinatore con bilance



MHP 5200
Bilancia multinatro



CWT 1000
Selezionatrice ponderale automatica



CWT 500
Bilancia di controllo automatica



ST A500B
Bilancia di controllo automatica



ST EPW310
Bilancia dinamica per sacchetti

intelligent labelling solutions



GLM-B-S
Etichettatrice automatica



ILS 3000
Etichettatrice per imballaggi da trasporto



GLT maxx 9000
Etichettatrice per imballaggi da trasporto



GPH maxx 7-8-9000
Etichettatrice per pallets



ILS 3800
Etichettatrice per pallets

intelligent closing solutions



ICS 1000
Incollatrice automatica per confezioni di cartone

intelligent packaging solutions

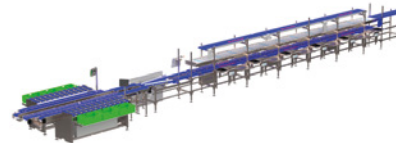

IPS: Linea con 4 livelli e tavoli di pesatura frontali e bilancia combinata semiautomatica MHP 3000



IPS: Linea con 4 livelli e tavoli di pesatura frontali, selezionatrice ponderale automatica ed etichettatrice



IPS small: Linea con 2 livelli e tavoli di pesatura frontali e selezionatrice ponderale automatica

smart software solutions

